

WAT-230V2 (G3.7) 1/4" Miniature Camera

Ultra-compact design for easy installation and limited space



Key features

- High resolution of 650TVL
- Min.illumination 0.1 lx F1.8
- Wide range power supply (DC+5 - +12V)
- Advanced setting available by OSD (On Screen Display) through an optional controller
- Various optional M12 lenses available (CS mount version available *MTO)

Dimensions

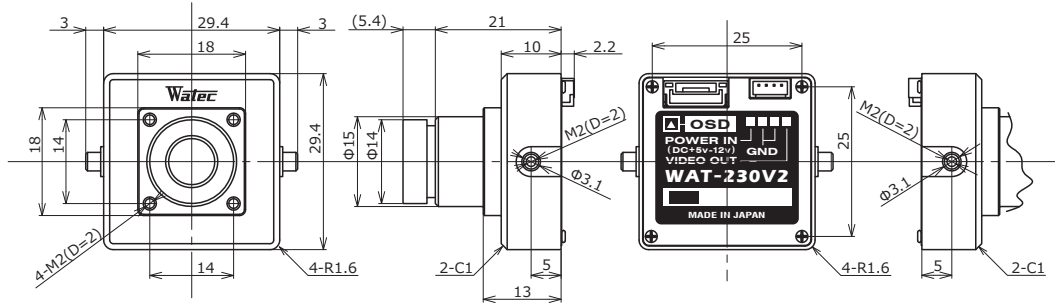

Specifications

Video standard		NTSC	PAL
Pick-up element		1/4 inch interline transfer CCD image sensor	
Number of effective pixels		976(H) × 494(V)	976(H) × 582(V)
Unit cell size		3.75μm(H) × 5.56μm(V)	3.75μm(H) × 4.69μm(V)
Imaging system		Ye, Cy, Mg, and G complementary color mosaic filters on chip	
Synchronizing system		Internal	
Scanning system		2:1 interlace	
Video output		Composite video, 1.0 V(p-p), 75Ω (Unbalanced)	
Resolution (H)		More than 650TVL (Center)	
Minimum illumination		0.1 lx F1.8	
S/N		More than 50dB	
Function settings		OSD(On Screen Display) operated by optional remote controller	
AE mode	Fixed	1/60, 1/100 sec.	1/50, 1/120 sec.
	EI	1/250, 1/500, 1/1000, 1/2000, 1/4000, 1/10000 sec.	
		1/60 - 1/100000 sec.	1/50 - 1/100000 sec.
White balance		ATW, PUSH, USER1, USER2, ANTI CR, MANUAL, PUSH LOCK	
AGC	ON	0 - 45dB	
	OFF	0dB	
MGC		8 steps (Selectable)	
Gamma characteristics		γ≈0.45	
Noise reduction		2DNR ON / OFF	
Back light compensation		OFF / BLC / HLC	
White blemish correction		Max 64 dots	
Privacy mask		8 masks	
Mirror image		ON (H-FLIP) / OFF	
Video level		0 - 255 (BRIGHTNESS)	
Setup level		7.5 IRE	0 IRE
Output switching		AUTO / COLOR / BW	
Sharpness		0 - 255 (SHARPNESS)	
Power supply		DC+5V - +12V	
Power consumption		0.775W/155mA (DC+5V), 0.75W/125mA (DC+6V), 0.78W/65mA (DC+12V)	
Operating temperature		-10 - +50°C	
Storage temperature		-30 - +70°C	
Operating / Storage humidity		95% RH or less (Without condensation)	
Lens mount		M12 P=0.5	
Standard lens		M3718BC-12 (f3.7 F1.8)	
Weight		Approx. 35g	
Accessory		4P cable	

Accessories
 Options

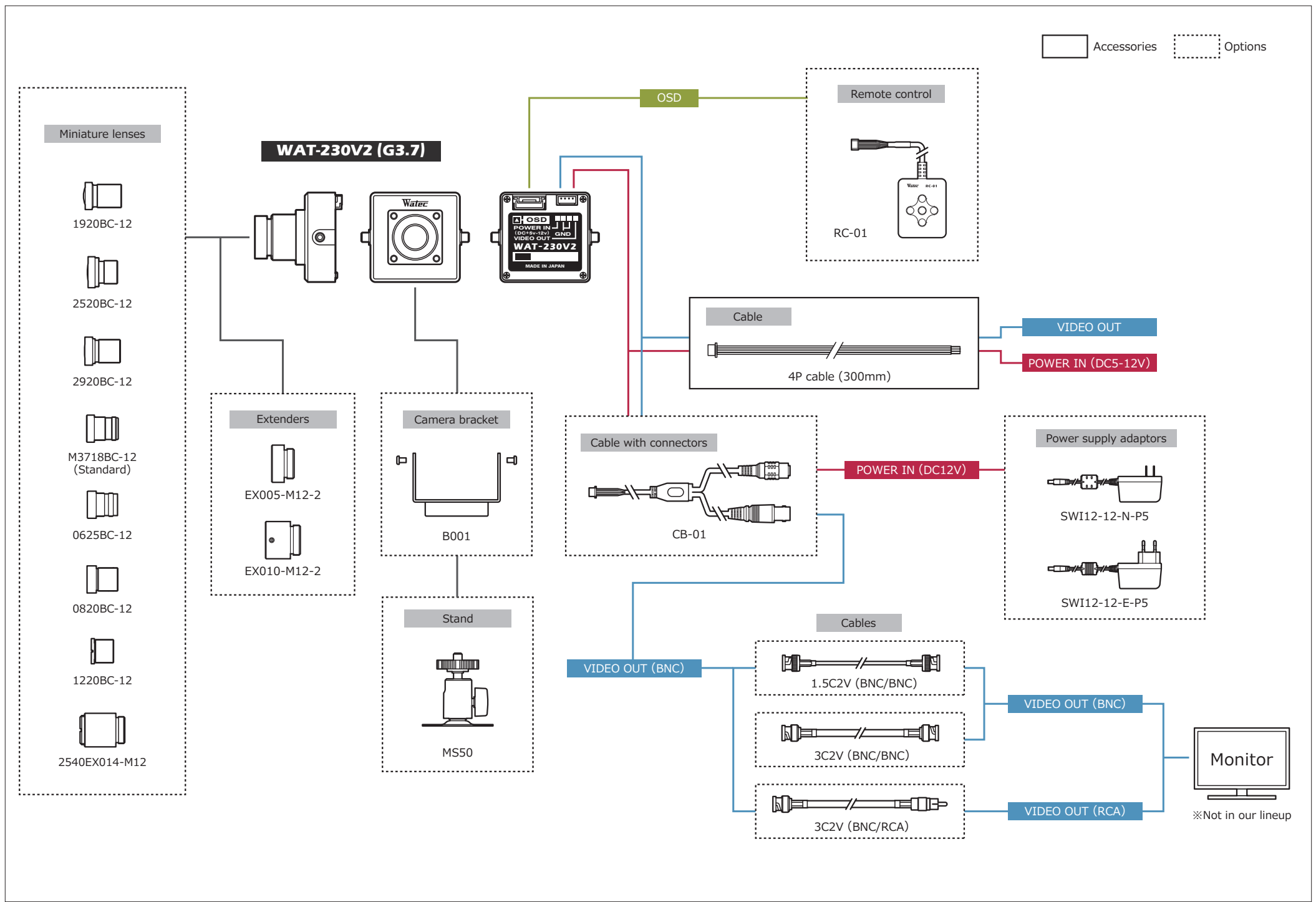

Miniature lenses

- 1920BC-12
- 2520BC-12
- 2920BC-12
- M3718BC-12 (Standard)
- 0625BC-12
- 0820BC-12
- 1220BC-12
- 2540EX014-M12

WAT-230V2 (G3.7)

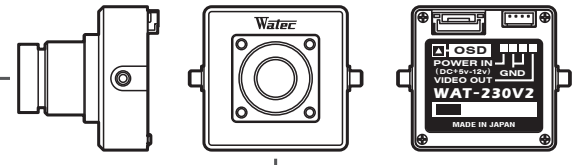

Extenders

- EX005-M12-2
- EX010-M12-2

Camera bracket

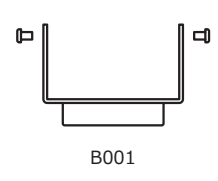

Stand



OSD

Remote control

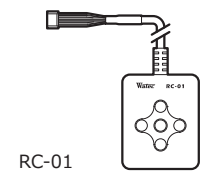

Cable

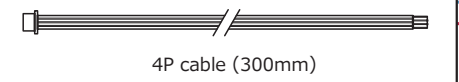

Cable with connectors

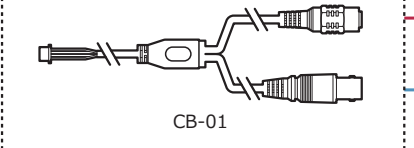

VIDEO OUT

POWER IN (DC5-12V)

POWER IN (DC12V)

Power supply adaptors

- SWI12-12-N-P5
- SWI12-12-E-P5

VIDEO OUT (BNC)

Cables

- 1.5C2V (BNC/BNC)
- 3C2V (BNC/BNC)
- 3C2V (BNC/RCA)

VIDEO OUT (BNC)

VIDEO OUT (RCA)



※Not in our lineup