

WAT-231S2 1/3" High Sensitivity Camera

Multi-function and high-performance model



Key features

- 1/3-inch CCD sensor with high sensitivity 0.02 lx F1.2 and resolution 540TVL
- Versatile use for general surveillance, microscope application and embedded system
- Flicker suppression electric iris controls flicker and exposure at the same time
- White balance, white blemish correction, back light compensation

Dimensions

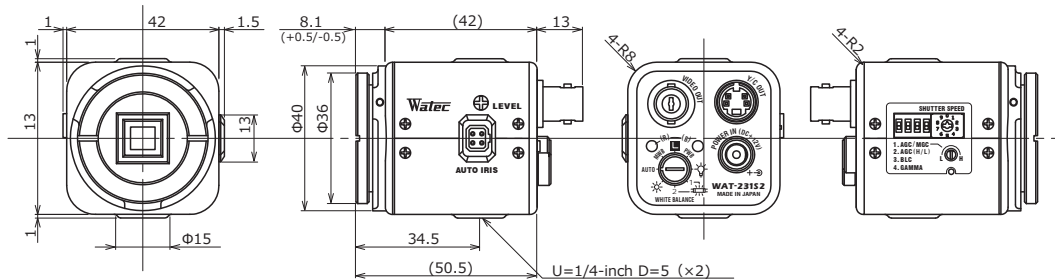

Specifications

Video standard		NTSC	PAL
Pick-up element		1/3 inch interline transfer CCD image sensor	
Number of effective pixels		768(H) × 494(V)	752(H) × 582(V)
Unit cell size		6.35μm(H) × 7.4μm(V)	6.5μm(H) × 6.25μm(V)
Imaging system		Ye, Cy, Mg, and G complementary color mosaic filters on chip	
Synchronizing system		Internal	
Scanning system		2:1 interlace	
Video outputs	BNC	Composite: 1.0 V(p-p) 75Ω (Unbalanced)	
	Y/C	Y: 1.0V(p-p), C: 0.3V(p-p) 75Ω	
Resolution (H)		More than 540TVL (Center)	
Minimum illumination		0.02 lx F1.2 (AGC=ON)	
S/N		50dB 以上 (AGC=0dB, γ=1.0)	
AE mode	Fixed	1/60, 1/100 sec.	1/50, 1/120 sec.
		1/250, 1/500, 1/1000, 1/2000, 1/5000, 1/10000, 1/100000 sec.	
	EI	1/60 - 1/100000 sec.	1/50 - 1/100000 sec.
		FL: 1/60 - 1/100000 sec. (Flicker suppression)	FL: 1/50 - 1/100000 sec. (Flicker suppression)
White balance		ATW (Color rolling suppression), PWB, MWB, PRESET (3200K, 4300K, 5100K, 6300K)	
AGC		HI: 0 - 38dB / LO: 0 - 32dB	
MGC		0 - 32dB	
Gamma characteristics		γ≈0.45 (ON) / γ=1.0 (OFF)	
Lens iris		Video / DC (EIAJ), Auto-select	
Back light compensation		ON / OFF	
White blemish correction		Max 32 dots	
Power supply		DC+12V±10%	
Power consumption		1.92W (160mA)	
Operating temperature		-10 - +50°C	
Storage temperature		-30 - +70°C	
Operating / Storage humidity		95%RH or less (Without condensation)	
Lens mount		CS mount (Back focus adjustable)	
Weight		Approx. 140g	
Accessories		WPDC12 (DC plug), AIC-G (Iris plug), Hex wrench	

Options

CS-mount lenses

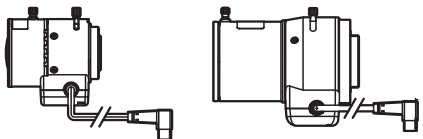

13VG308ASIR II 13VG1040ASIR

Miniature lenses / Mount adaptors

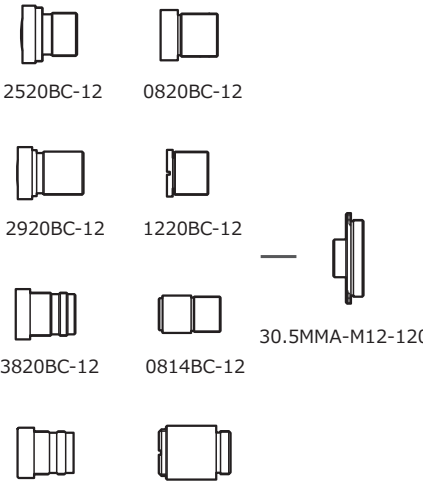

2520BC-12 0820BC-12
2920BC-12 1220BC-12
3820BC-12 0814BC-12 30.5MMA-M12-120
0625BC-12 2540EX014-M12

WAT-231S2

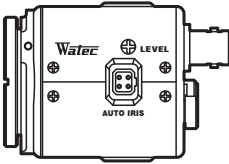

VIDEO OUT (BNC)

VIDEO OUT (Y/C)

POWER IN (DC12V)



Cables

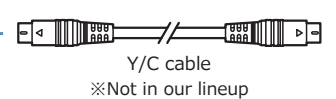
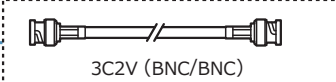

BNC

RCA

Y/C



※Not in our lineup

Power supply adaptors

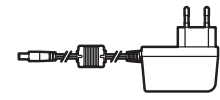
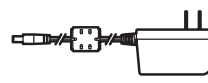

Stands

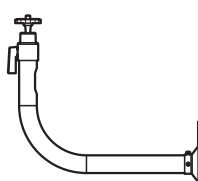
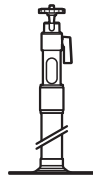

C-mount lenses
※Not in our lineup

C-mount adaptor



Water resistant camera housing / Mounting brackets

